

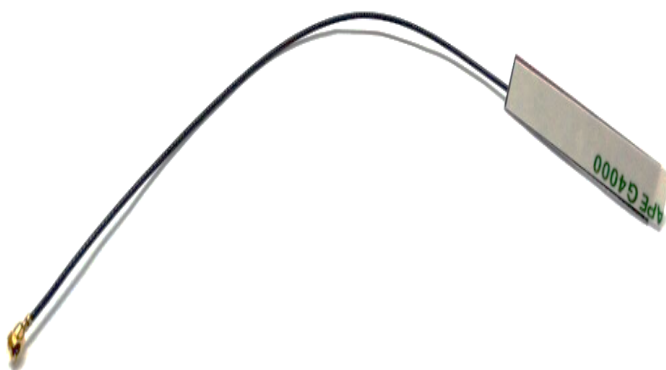

The World Wide Leader in Antenna

# 2.4GHz Antenna

## XG-TC-9/2.4IPEX015



Frequency : 2.4-2.5GHz

V.S.W.R : <2.0:1

Impedance : 50 ohm

Connector : IPEX (IV)

Cable : 1.13

Material : PCB

Weight : ≐ 3g

Dimension : 39.9 x 8.4mm

Color : Black

Mounting : 3M Tape

Polarization : Linear (H) or (V)

Temperature : -30°C to +65°C

EVERCOM COMMUNICAITON TECHNOLOGY CO., LTD.

No.108 Jiesin St. Taoyuan District Taoyuan City 33063, Taiwan R.O.C.

Tel: +886-3- 376- 5678 Fax: +886-3- 376- 5319 E-Mail: service@evercomtech.com

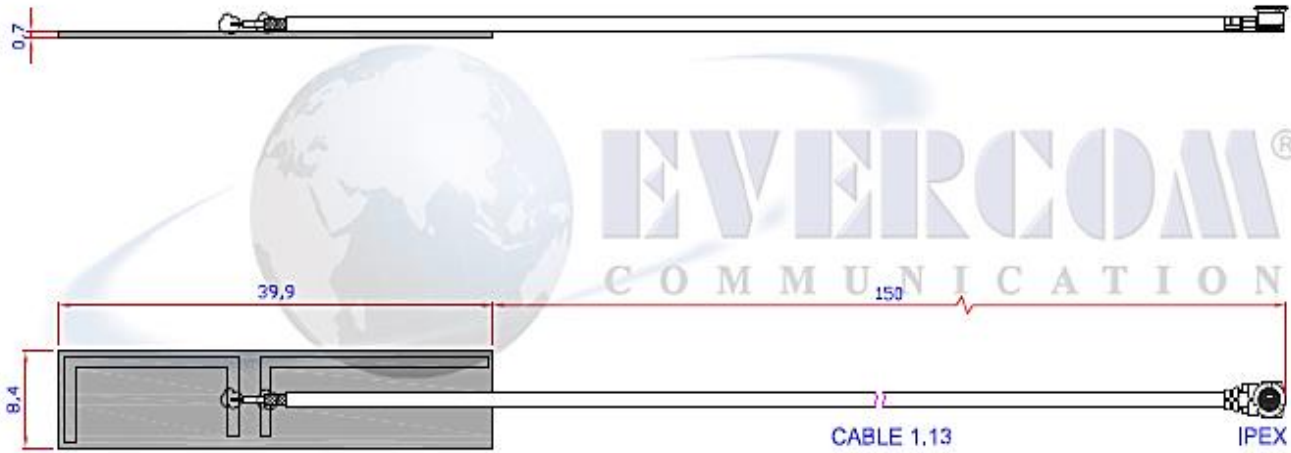

	EVERCOM COMMUNICATION TECHNOLOGY CO; LTD.			CHECKED BY	APPROVAL BY	DESIGNED BY	SCALE	UNIT
	MODEL NAME	MODEL NO.	TC-3/2.4IPEX015		<i>Ben</i> 20170519	C.H.C 2017.05.19	2:1	mm

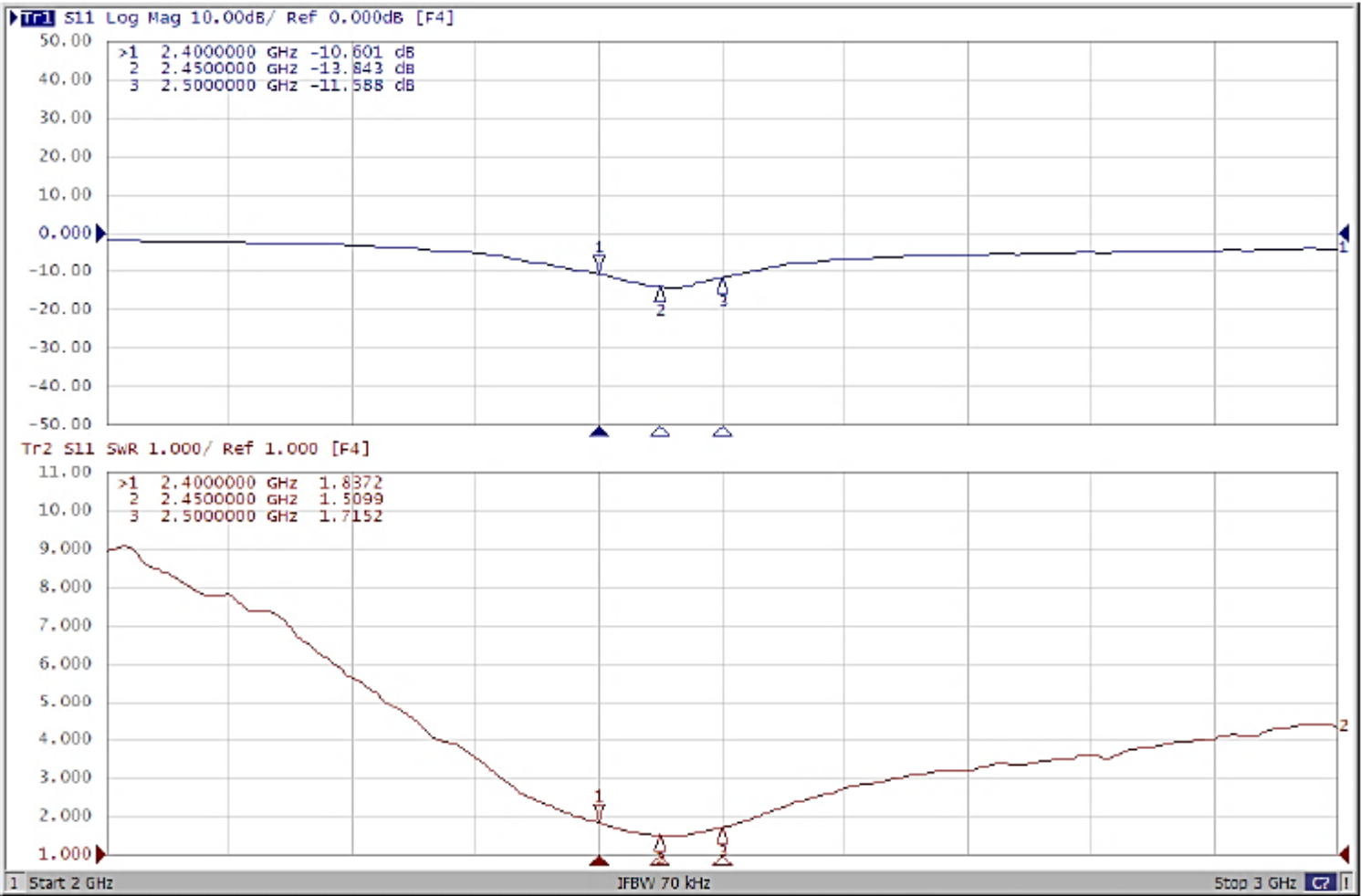

### 3. Gain / Efficiency Test Data

2400MH

2500MH

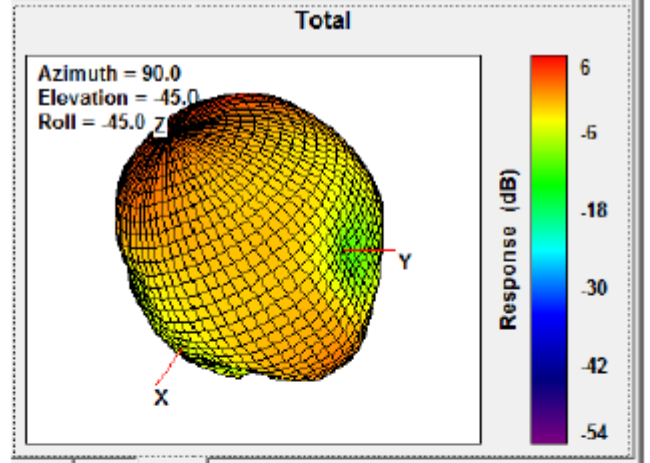
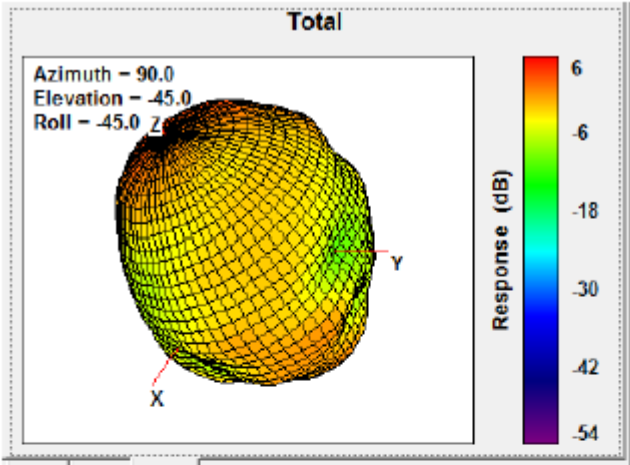

MHZ	Eff(%)
2400	78
2410	78
2420	79
2430	80
2440	81
2450	83
2460	82
2470	80
2480	79
2490	78
2500	78

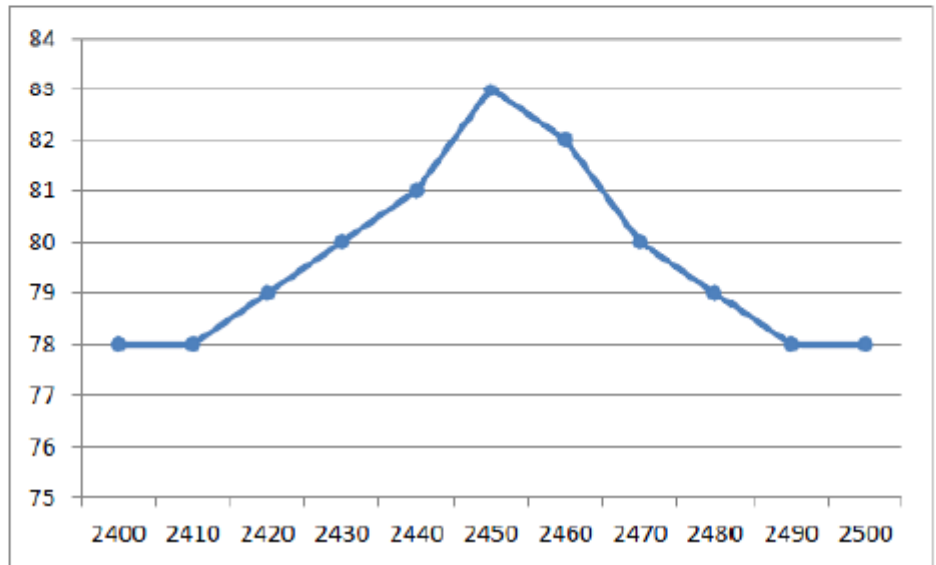

MHZ	Gain(dBi)
2400	1.8
2410	1.9
2420	2
2430	2
2440	2.1
2450	2.3
2460	2.2
2470	2
2480	1.9
2490	1.8
2500	1.5

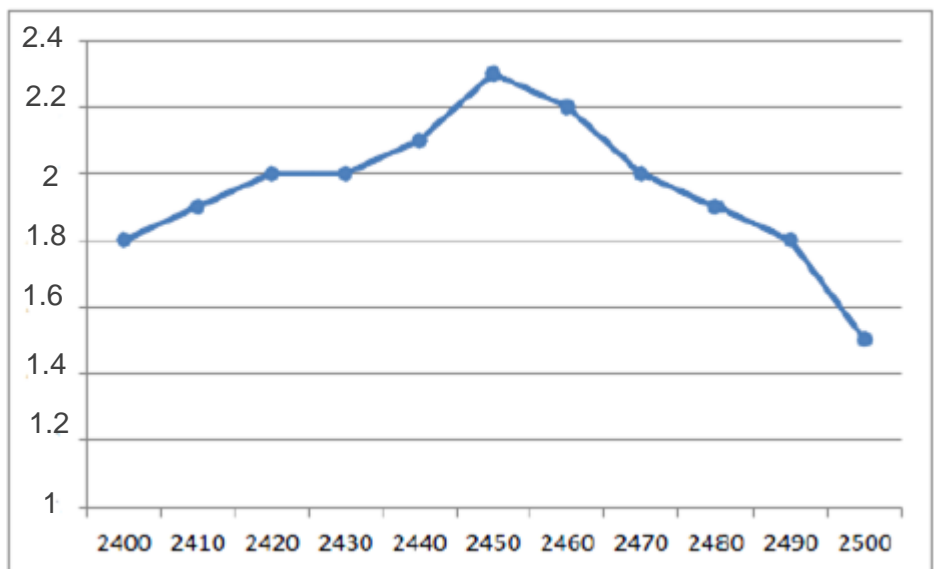



*The World Wide Leader in Antenna*

# Packaging

\*1 pc Antenna  
PE bag/ each

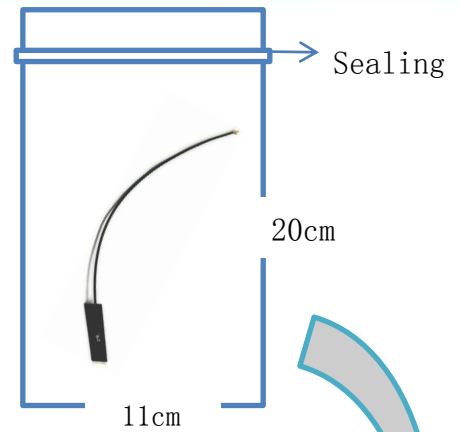

1000 pcs per carton  
Carton Dimensions: 40\*30\*20cm

